 Made in Denmark

HETA

Content

- 3 Cozy heat for living
- 4 Choosing the proper stove

STOVE

- 6 Scan-Line 900
- 16 Scan-Line 800

- 34 We care about the environment

- 36 Scan-Line 8
- 40 Scan-Line 1000
- 44 Scan-Line 500 + Napoli + Turin
- 50 Scan-Line 7
- 53 Stone options
- 54 Ambition 5 + 8
- 56 Inspire

- 60 Scan-Line 80
- 62 Scan-Line 40 + 50
- 64 Scan-Line 10 + 20 + 30
- 65 Scan-Line Tour
- 69 Scan-Line Solid C

- 70 Stay warm for many hours
- 71 HETA Automatic Combustion

- 72 Scan-Line 95 + 100

INSERT

- 74 Scan-Line Prestige
- 76 Scan-Line Panorama
- 78 Vista
- 80 Scan-Line Classic
- 82 Inspire

- 84 Builders hole measurements

PELLET STOVE

- 88 Scan-Line Green 150
- 90 Scan-Line Green 250

- 94 Scan-Line 805 Aqua
- 96 Scan-Line 800 Gas

OUTDOOR

- 98 Quad
- 100 Tipi

ACCESSORIES

- 104 Accessories for stoves
- 106 Glass plates

Cozy heat for living.

You get it all with HETA.

HETA is Danish design and quality, where we have catered for every detail. HETA stoves, inserts and pellet stoves offer a great source of heat in your home, add to the decor and spread coziness on cold days. When you choose a HETA stove, you get cosy heat for living, peace of mind, Danish design and quality, developed over more than 150 years.

In Lemvig, on the west coast of Jutland, HETA is manufacturing all their stoves, inserts, pellet stoves, aqua stoves, thermal mass stoves and outdoor products in steel and cast iron, from idea to finished product.

We are constantly developing, updating and extending our impressive range of stoves. The craftsmanship and the pride of creating our own products are still the main characteristics of HETA, and these values are clearly reflected in our innovative and functional stoves.

We feel strongly about the environment and our common future. For many years, HETA has worked intensively on more environmentally-friendly production of wood-burning stoves, and today, they are some of the most clean-burning wood-burning stoves in Europe.

All HETA stoves have impressively high burning value, so you get more out of your firewood, and the amount of polluting gases is reduced as much as possible before they leave the chimney.

All stoves are inspected before leaving the factory. In addition to that, you naturally get a five year warrant on your product, covering manufacturer's defects.



HETA is a family-owned business, located in Lemvig near the west coast of Jutland in Denmark. Today, HETA is selling stoves to customers in 22 countries worldwide. HETA was founded in 1972 with Erik Bach at the steering wheel for the first many years. Today, Erik's two sons, Carsten Bach and Martin Bach, are heading the company.

Choosing the proper stove

There is a large range to choose from and choosing the right stove is not so simple.

Before you decide, ask yourself the following five questions:



1. The size of your stove?

Is your stove to be the primary source of heating or will it just provide a cozy atmosphere as a supplement to your present heat source? The answer is crucial for your choice of stove.

A stove's output is measured in kilowatts (kW). kW is an expression of the amount of heat given out by a stove. As a rule-of-thumb, 1 kW can warm up a 10-20 m² room with an average ceiling height, depending on the room's insulation. The value "kW tested" shows a stove's output has been tested in accordance with the European Committee for Standardisation's EN standard.

Be careful not to buy a stove with too many kW, the result may be that you use it with too little air supply so that the combustion is not optimum.

2. Radiation or convection?

The majority of new stoves use convection, where air is circulated between an inner and outer steel mantle. When the air is heated it rises and heats the room. The convectional heat from a stove warms evenly, but requires a stove to be placed physically closer than a radiation stove. Therefore, you must consider where your stove should be installed. Radiation gives a more intense heat and will be suitable for small rooms.

3. Plate steel or cast iron?

Both kinds of materials make excellent stoves and inserts. All HETA's products have both plate steel and cast iron. The allocation set according to durability and design.

4. Steel, ceramic, granite or soapstone?

HETA has a wide selection of finishes from steel, casted tiles, ceramic, soapstone, limestone and sandstone cladding options are available, depending on the model you choose. The choice of material is a matter of style and design, though each material has particular characteristics. A stove made entirely from steel or cast iron warms up faster than a ceramics or stone and it also cools faster when the fire has gone out.

Ceramics and especially soapstone take a little longer to warm up, but stay warm long after the fire has gone out. The slightly larger soapstone stoves stay warm for many hours and can easily keep a room or house nice and warm through the night, so you will not wake up cold in the morning.

5. Which combustion technology should your stove have?

For both financial and environmental reasons, you should always pay attention to how your wood-burning stove burns. Due to the completely unique dimensioning of the firebox and associated airways of HETA stoves, CO₂ and harmful particles are reduced as much as possible. HETA's modern combustion technology is extremely efficient and removes soot particles from the glass door and through the smoke channels. When you light up, a pleasant heat immediately radiates through the large glass panes, and then the convection system soon begins to distribute the heat and cosiness in the room and the adjacent spaces.

Scan-Line 900

Exclusivity throughout

*Scan-Line 900
glass door*



The Scan-Line 900 series is a stunning wood stove with sharp lines where nothing “disturbs” the eye. The exclusive set of handles that are hidden in the stove’s curves are designed for easy use and a unique silicone finish to keep them cool for your pleasure.

Scan-Line 900 is no ordinary wood stove, with its impressive large glass, single air control and optional self-closing door allowing you to enjoy the cozy flames in the large combustion chamber. The 900 is

a modern wood stove with all the HETA tradition, an integrated fireplace toolset and a large 5-liter ash bucket is nestled in behind the lower door.

The option of a glass door is available for all models in this impressive series, giving HETA’s 900 series modern, stylish design an eloquent look in any home.

**Scan-Line 900****Scan-Line 900**
soapstone top**Scan-Line 900**
soapstone**Scan-Line 900**
glass door
soapstone top**Scan-Line 900**
blackwood top**Scan-Line 900**
blackwood**Scan-Line 900**
limestone top**Scan-Line 900**
limestone



*Scan-Line 900B
soapstone*

Scan-Line 900B

With Scan-Line 900B or 900B with side windows, you can relax in the cozy, warm atmosphere while creating your favorite dishes in the baking oven. The large baking oven is equipped with an adjustable rack for convenience, it also has a unique feature which creates convection as well as removes condensation while baking your favorite dishes.

**Scan-Line 900B****Scan-Line 900B**
soapstone top**Scan-Line 900B**
soapstone**Scan-Line 900B**
glass door + blackwood**Scan-Line 900B**
blackwood top**Scan-Line 900B**
blackwood**Scan-Line 900B**
limestone top**Scan-Line 900B**
limestone



Scan-Line 900S

HETA's Scan-Line 900S or 900S with side windows, is the model for you if you're looking for the most out of your stove's heating capabilities. The Scan-Line 900S models have therma stones, they store the heat as you are firing in your stove. In the combination with one of the three stone finishes soapstone, blackwood or limestone, you will be heating your house for 10-12 hours after the fire has died out.

**Scan-Line 900S****Scan-Line 900S**
soapstone top**Scan-Line 900S**
soapstone**Scan-Line 900S**
glass door + soapstone**Scan-Line 900S**
blackwood top**Scan-Line 900S**
blackwood**Scan-Line 900S**
limestone top**Scan-Line 900S**
limestone



Scan-Line 900 side windows

With our selection of beautiful stones, you can make your stove a statement in your house like fine décor.

Choose from one of four finishes like soapstone, blackwood, limestone and steel on your Scan-Line 900 with or without side windows.

Scan-Line 900 side windows

Scan-Line 900
side windows
glass door



Scan-Line 900
side windows
blackwood



Scan-Line 900B
side windows



Scan-Line 900B
side windows + glass door
imestone top



Scan-Line 900B
side windows
soapstone



Scan-Line 900S
side windows
soapstone



Scan-Line 900S
side windows
blackwood top



Scan-Line 900S
side windows
limestone

Technical info

900 + 900B + 900S + side windows

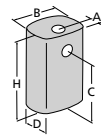

Oven model	900	900B	900S	900 side windows	900B side windows	900S side windows	options
mm	 A: 181 B: 515 C: 1060 D: 421 H: 1191 / 1211	 A: 181 B: 515 C: 1330 D: 421 H: 1491 / 1511	 A: 181 B: 515 C: 1060 D: 421 H: 1491 / 1511	 A: 181 B: 515 C: 1060 D: 421 H: 1191 / 1211	 A: 181 B: 515 C: 1330 D: 421 H: 1491 / 1511	 A: 181 B: 515 C: 1060 D: 421 H: 1491 / 1511	 Soapstone  Blackwood  Limestone  Paint black/grey
Floor to top outlet mm	1167	1467	1168	1167	1467	1167	
Energy efficiency class	A+	A+	A+	A+	A+	A+	
Nominal kW	6,8	6,8	6,8	6,6	6,6	6,6	
Weight kg	147 → 201	177 → 243	214 → 298	147 → 186	177 → 227	214 → 264	
Fuel volume kg	1,52	1,52	1,52	1,71	1,71	1,71	
Combustion chamber width mm	347	347	347	347	347	347	
Distance to flammable materials							
At the sides mm	350	350	350	400	400	400	
Behind stove mm	175	175	175	150 / 125	150 / 125	150 / 125	
Installed in a 45° corner	100	100	100	200	200	200	
Distance to furniture mm	1000	1000	1000	900	900	900	
Efficiency Ecodesign requirement of 75%	83	83	83	82	82	82	
Dust measurement Ecodesign requirement of 40 Mg/Nm ³ 13% O ₂	9	9	9	9	9	9	

Details



Integrated control handles



5 Liter ash bucket and fireside tool set



Glas door (optional)



Side windows

More on heta.dk



*Scan-Line 900
soapstone*

Scan-Line 800



Scan-Line 800

Beautiful and convenient

Scan-Line 800 is an ellipse-shaped stove in a smart and stylish design mainly in cast iron on the visible surfaces. Scan-Line 800 beautiful and convenient all at the same time.

Scan-Line 800 series comprises of six different variants at different heights. The models can be supplied with steel, soapstone, sandstone, blackwood, limestone or ceramic cladding.

Available is also accumulating large volumes of heat, a baking oven, swivel models and combustion chambers at different heights.

**Scan-Line 800****Scan-Line 800**
soapstone top**Scan-Line 800**
soapstone**Scan-Line 800**
ceramic**Scan-Line 800**
sandstone top**Scan-Line 800**
sandstone**Scan-Line 800**
blackwood**Scan-Line 800**
limestone

Scan-Line 810

*Scan-Line 810
limestone*



Scan-Line 810**Scan-Line 810****Scan-Line 810**
soapstone top**Scan-Line 810**
soapstone**Scan-Line 810**
ceramic**Scan-Line 810**
sandstone**Scan-Line 810**
blackwood**Scan-Line 810**
limestone**Scan-Line 810**
high top

Scan-Line 820B

Visual attraction in your living room

If you choose Scan-Line 820B with soapstone you have ensured visual attraction in your living room and you can bake at the same time. Soapstone is a beautiful natural material with a fantastic heat accumulation and it stays warm long after the fire has gone out.

*Scan-Line 820B
soapstone*



Scan-Line 820B

Scan-Line 820B



Scan-Line 820B
soapstone top



Scan-Line 820B
soapstone



Scan-Line 820B
sandstone



Scan-Line 820B
limestone



Scan-Line 820B
blackwood



Scan-Line 820B
high top



Scan-Line 820B
ceramic

Scan-Line 820S

*Scan-Line 820S
blackwood*



**Scan-Line 820S****Scan-Line 820S**
soapstone top**Scan-Line 820S**
soapstone**Scan-Line 820S**
sandstone**Scan-Line 820S**
limestone**Scan-Line 820S**
ceramic**Scan-Line 820S**
blackwood**Scan-Line 820S**
high top

**Scan-Line 830 + 830S +
830B + 840B + 840S**



Scan-Line 830XL-B

Scan-Line 830 + 830S + 830B + 840B + 840S

Scan-Line 830
soapstone top



Scan-Line 830
soapstone



Scan-Line 830XL-B
soapstone



Scan-Line 830XL-B
sandstone top



Scan-Line 840B
ceramic



Scan-Line 840S



Scan-Line 840S
blackwood top



Scan-Line 840S
limestone top

Scan-Line 850



*Scan-Line 850 wall hanging
blackwood top*



Scan-Line 850
rotating pedestal



Scan-Line 850
rotating pedestal
soapstone top



Scan-Line 850
rotating pedestal
soapstone



Scan-Line 850
rotating pedestal
tobacco



Scan-Line 850
rotating pedestal
ceramic



Scan-Line 850
wall hanging



Scan-Line 850
wall hanging
high top



Scan-Line 850
rotating pedestal
limestone top

Scan-Line 800 side windows

*Scan-Line 800M
side windows*



Scan-Line 800 side windows

Scan-Line 800M
side windows



Scan-Line 820M
side windows



Scan-Line 820MB
side windows



Scan-Line 800
side windows



Scan-Line 820
side windows



Scan-Line 820B
side windows



Scan-Line 850M
rotating pedestal
side windows



Scan-Line 850M
wall hanging
side windows

Scan-Line 800M + 810M + 820MB + 820MS + 850M

Scan-Line 800M



 **HETA** Scan-Line 800M + 810M + 820MB + 820MS + 850M



Scan-Line 800M



Scan-Line 810M



Scan-Line 820MB



Scan-Line 820MS



Scan-Line 850M
rotating pedestal



Scan-Line 850M
wall hanging

Technical info

800 + 810 + 820B + 820S + 830 + 830B + 830S + 840B + 840S



Oven model	800	810	820B + S	830	830B + S	840B + S	Options
mm	 A: 214 B: 548 C: 880 D: 440 H: 1043	 A: 218 B: 548 C: 1162 D: 440 H: 1357	 A: 218 B: 548 C: 880 D: 440 H: 1357	 A: 218 B: 548 C: 880 D: 440 H: 1639	 A: 218 B: 548 C: 880 D: 440 H: 1639	 A: 218 / 214 B: 548 C: 1162 D: 440 H: 1639 / 1607	 Soapstone Blackwood Limestone Tobacco Ceramic 42 colours Paint black/grey
Floor to top outlet mm	1004	1286	1004	1383	1383	1286 / 1577	
Energy efficiency class	A+	A+	A+	A+	A+	A+	
Nominal kW	6,8	6,8	6,8	6,8	6,8	6,8	
Weight kg	113 → 200	130 → 238	137 → 285	190 → 366	190 → 366	S: 147 → 328 B: 159 → 290	
Fuel volume kg	1,5	1,5	1,5	1,5	1,5	1,5	
Combustion chamber width mm	330	330	330	330	330	330	
Distance to flammable materials At the sides mm	300	300	300	300	300	300	
Behind stove mm	125	125	125	125	125	125	
Distance to furniture mm	900	900	900	900	900	900	
Efficiency Ecodesign requirement of 75%	81	81	81	81	81	81	
Dust measurement Ecodesign requirement of 40 Mg/Nm ³ 13% O ₂	24	24	24	24	24	24	

Stone and ceramics options do not apply to M models and models with side glass

Details



8 Liter ash bucket



Fireside tool set



Optimal combustion



Baking oven

More on heta.dk

Technical info

850 + 800 side windows + 800M + 810M + 820MB + 820MS + 850M



Oven model	850 wall	800 side windows	800M	810M	820MB	820MS	850M	options
mm	 A: 242 B: 548 / 560 C: 516 D: 468 / 469 H: 682 / 711	 A: 214 B: 547 / 560 C: 880 D: 440 / 445 H: 1043 / 1075	 A: 214 B: 467 C: 880 D: 440 H: 1043	 A: 214 B: 467 C: 880 / 1162 D: 440 H: 1043 / 1325	 A: 214 B: 548 C: 880 D: 440 H: 1325	 A: 214 B: 548 C: 880 D: 440 H: 1325	 A: 218 B: 560 C: 885 D: 445 H: 1035 / 1048	 Soapstone Blackwood Limestone Tobacco Ceramic 42 colours Paint black/grey Stone and ceramics options do not apply to M models and models with side glass
Floor to top outlet mm	640	1004	1004	1004 / 1286	1004 / 1295	1004 / 1295	996 / 1013	
Energy efficiency class	A+	A	A+	A+	A+	A+	A+	
Nominal kW	6,8	6	6,8	6,8	6,8	6,8	6,8	
Weight kg	102 → 158	119 → 128	113	122 → 137	137 → 285	137 → 285	112 → 168	
Fuel volume kg	1,5	1,5	1,5	1,5	1,5	1,5	1,5	
Combustion chamber width mm	330	330	330	330	330	330	330	
Distance to flammable materials At the sides mm Behind stove mm	300 125	450 130	340 125	340 125	300 125	300 125	300 125	
Distance to furniture mm	900	850	900	900	900	900	900	
Efficiency Ecodesign requirement of 75%	81	80	81	81	81	81	81	
Dust measurement Ecodesign requirement of 40 Mg/Nm³ 13% O₂	24	6	24	24	24	24	24	

Details



8 Liter ash bucket



Fireside tool set



Side windows



Baking oven

More on hetadk

Effective combustion

The environment and our common future are very important to us. For many years, HETA has worked intensively on more environmentally-friendly production of clean-burning wood-burning stoves that place the least possible burden on the environment.

All HETA stoves have an impressively high degree of efficiency, so you get more out of your firewood, and polluting gases are burned off as much as possible before they leave the chimney.

HETA's wood-burning stoves are some of the most clean-burning stoves in Europe. They are tested according to current regulations in Norway, Denmark and Germany and the new Ecodesign regulations. HETA's completely unique combustion technology and airways mean that CO₂ and harmful particles are reduced as much as possible.

What is Ecodesign?

The Ecodesign, is a regulation to ensure a wood stove conforms to the strict regulations in Europe. Since before Ecodesign, HETA has only developed and tested stoves to this standard, meaning any HETA stove sold today conforms to the Ecodesign standard. Giving you peace of mind when enjoying the cozy warm by your HETA wood, pellet or gas stove.

There is more to read on heta.dk



HETA's combustion technology

HETA's combustion technology means that the combustion air flows easily and is supplied to the combustion without resistance. The preheated tertiary air supply burns a large amount of gases before the smoke goes up the chimney. Hot convection air is the air that is distributed into the surrounding rooms and, together with the radiant heat from the glass pane, constitutes the direct source of heat.

The heat is better exploited, and you can enjoy the view of the flames through the large glass window in the door - completely without soot.

The completely unique dimensioning of the fire chamber and associated airways of HETA stoves means that CO₂ and harmful particles are reduced as much as possible.

HETA's modern combustion technology is extremely efficient and removes soot particles on the glass door and through the smoke channels. When you light up, a pleasant heat immediately radiates through the large glass panes, and then the convection system soon begins to distribute the heat and cosiness in the room and the adjacent spaces.

Many of our products also have accumulation stones - soapstone, sandstone, granite or ceramic - that retain heat over many hours and slowly release it.

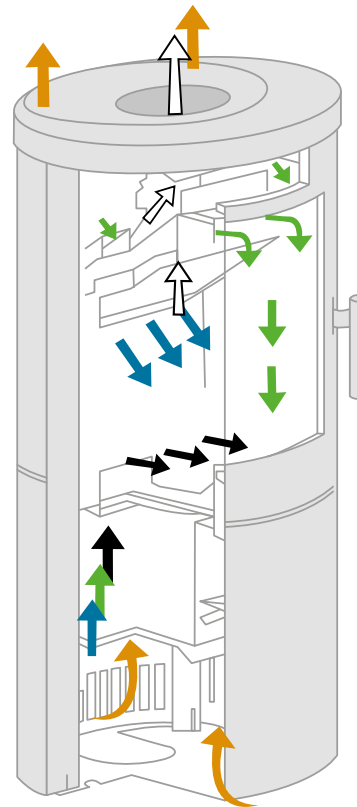

Black = primary
Green = secondary
Blue = tertiary
White = flue gas
Orange = convection air

Scan-Line 8

Small and smart

With its circular design, Scan-Line 8 generates attention in any home. Scan-Line 8 has a diameter of just 44 cm, a height of 100 cm and works well in many rooms in various different types of home. Scan-Line 8 is available in different materials and designs and has numerous smart functions.

With Scan-Line 8 you get an award-winning stove that has won the title of best wood-burning stove up to 5 kW at the Hearth & Home exhibition in England, as well as the Eco Stove Plus 2018 award at the Budma exhibition in Poland due to the stove's low level of PM dust at 13% oxygen of $< 3 / \text{m}^3$.



*Scan-Line 8
soapstone / copper trims*





Scan-Line 8
casted sides
silver trims



Scan-Line 8
casted sides
red trims



Scan-Line 8
casted sides + soapstone top
black trims



Scan-Line 8
casted sides + soapstone top
copper trims



Scan-Line 8
soapstone
black trims



Scan-Line 8
soapstone
silver trims



Scan-Line 8
soapstone
copper trims



Scan-Line 8
soapstone
red trims



Scan-Line 8
grey



Scan-Line 8
soapstone top



Scan-Line 8
side windows



Scan-Line 8
side windows
soapstone top

Technical info

8 + side windows



Oven model	8	8 side windows	Options
mm	<p>A: 222 B: 445 C: 875 D: 445 H: 1011 / 1029</p>	<p>A: 222 B: 445 C: 875 D: 445 H: 1011 / 1029</p>	Soapstone Paint black/grey
Floor to top outlet mm	981	981	ONLY soapstone top on side windows
Energy efficiency class	A+	A+	
Nominal kW	4,7	4,7	
Weight kg	100 → 135	105 → 110	
Fuel volume kg	1,1	1,1	
Combustion chamber width mm	300	300	
Distance to flammable materials			
At the sides mm	350	400	
Behind stove mm	120	100	
Distance to furniture mm	850	700	
Efficiency Ecodesign requirement of 75%	81	81	
Dust measurement Ecodesign requirement of 40 Mg/Nm ³ 13% D ₂	<3	<3	



Details



5 Liter ash bucket
Soft close



Air regulation
and handle



Swivel plate
and fresh air



Colored trims

More on heta.dk



*Scan-Line 8
side windows
soapstone top*

Scan-Line 1000

Accommodates pieces of wood up to 50 cm

Cannot be bothered chopping wood? Then Scan-Line 1000 must move in with you. HETA's large stove Scan-Line 1000 can accommodate large pieces of wood up to 50 centimetres.

HETA Scan-Line 1000 is robust without filling the room. The stove is built in heavy steel and cast iron and has almost unmatched possibilities for collecting and releasing heat. Behind the lower door you will find the large eight-litre ash pan and there is of course also your fireside tool set.

Product data

- > 50 cm wood
- > Fireside tool set
- > 8 Liter ash bucket
- > Automatic closing



*Scan-Line 1000S
soapstone*



Scan-Line 1000



Scan-Line 1000
soapstone top



Scan-Line 1000
soapstone



Scan-Line 1000
blackwood top



Scan-Line 1000S



Scan-Line 1000S
soapstone top



Scan-Line 1000B
soapstone



Scan-Line 1000B
blackwood

Technical info



1000 + 1000S + 1000B

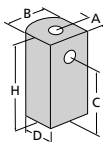
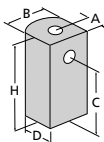
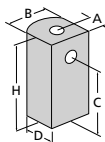

Oven model	1000	1000S	1000B
mm	 <p>A: 243 B: 767 C: 801 D: 476 H: 945 / 958</p>	 <p>A: 243 B: 767 C: 801 / 1166 D: 476 H: 1305 / 1292</p>	 <p>A: 243 B: 767 C: 801 / 1166 D: 476 H: 1305 / 1292</p>
Floor to top outlet mm	919	919 / 1260	919 / 1260
Energy efficiency class	A+	A+	A+
Nominal kW	7,7	7,7	7,7
Weight kg	176 → 244	302 → 391	231 → 319
Fuel volume kg	1,8	1,8	1,8
Combustion chamber width mm	550	550	550
Distance to flammable materials At the sides mm Behind stove mm	425 120	425 120	425 120
Distance to furniture mm	1300	1300	1300
Efficiency Ecodesign requirement of 75%	85	85	85
Dust measurement Ecodesign requirement of 40 Mg/Nm ³ 13% O ₂	8	8	8

>

Options

-  Soapstone
-  Blackwood
-  Paint black/grey

Details



Integrated control handles



8 Liter ash bucket and fireside tool set



Large baking stove



Therma-stones

More on hetadk

Scan-Line 500 + 510

A choice of many models

Scan-Line 500 + 510 + 520B series is based on the steel models, available in 8 different versions.

These are supplemented by soapstone tops, complete soapstone, complete blackwood and ceramic models in 42 different colours, which can be freely combined just as you dream about.

The combustion chamber can accommodate a lot of wood, and the Scan-Line 500 series naturally meets all current regulatory requirements, thanks to HETA's modern combustion technology.

*Scan-Line 510
soapstone*

Product data

- > A choice of many materials and colours
- > Unrivalled combustion
- > Large and deep combustion chamber



**Scan-Line 500****Scan-Line 500**
soapstone top**Scan-Line 500**
soapstone**Scan-Line 500**
ceramic**Scan-Line 510****Scan-Line 510**
soapstone top**Scan-Line 510**
soapstone**Scan-Line 510**
blackwood



Scan-Line 520B



Scan-Line 520B
soapstone



Scan-Line 520B
blackwood



Scan-Line 520B
ceramic



Scan-Line 520W
ceramic



Turin
soapstone



Turin B
soapstone



Napoli
soapstone

Scan-Line 520B + 520W + Turin + Napoli

HETA classics

Scan-Line Napoli and Scan-Line Turin are HETA classics. Both stoves have a generous soapstone or ceramic cladding. Scan-Line Napoli and Scan-Line Turin are available in as many as 42 different colours in the ceramic range. The soapstone provides extensive heat release over time.

Product data

- > Beautiful ellipseshaped model
- > Choose among many different claddings
- > The soapstone provides extensive heat release over time

*Scan-Line Turin
soapstone*



Technical info

500 + 510 + 520B + 520W + Turin + Napoli



Oven model	500	510	520B + W	options	Turin	Napoli	options
mm	<p>A: 141 / 147 B: 504 / 570 C: 794 D: 468 / 498 H: 1010 / 1030</p>	<p>A: 141 B: 504 C: 974 / 794 D: 468 H: 1190</p>	<p>A: 141 / 147 B: 504 / 570 C: 794 D: 468 / 498 H: 1190 / 1210</p>	Soapstone Blackwood Ceramic 42 colours Paint black/grey <p>Only complete blackwood on Scan-Line 510 / 520B</p>	<p>A: 157 B: 614 C: 836 D: 486 H: 1302</p>	<p>A: 157 B: 614 C: 836 D: 486 H: 1056</p>	Soapstone Ceramic 42 colours Paint black/grey
Floor to top outlet mm	930	1110	1163		1257	972	
Energy efficiency class	A+	A+	A+		A+	A+	
Nominal kW	6	6	6		6	6	
Weight kg	108 → 185	115 → 214	134 → 229		186 → 268	142 → 213	
Fuel volume kg	1,24	1,24	1,24		1,24	1,24	
Combustion chamber width mm	340	340	340		340	340	
Distance to flammable materials At the sides mm Behind stove mm	350 150	350 150	350 150		350 150	350 150	
Distance to furniture mm	1000	1000	1000		1000	1000	
Efficiency Ecodesign requirement of 75%	82	82	82		82	82	
Dust measurement Ecodesign requirement of 40 Mg/Nm ³ 13% O ₂	16	16	16		16	16	

Details



8 Liter ash bucket



Cast iron door



Optimal combustion



Baking oven

More on heta.dk

Scan-Line

550 + 551 + 560B + 560S + 590

Technical info

550 + 551 + 560B + 560S + 590



Scan-Line 560B



Scan-Line 560S



Scan-Line 551



Scan-Line 590



Oven model	550 + 551	560B + S	590
mm	<p>A: 148 B: 476 / 558 C: 921 D: 402 H: 1117</p>	<p>A: 148 B: 476 C: 922 D: 402 H: 1533</p>	<p>A: 148 B: 504 C: 794 D: 468/469 H: 1285/1295</p>
Floor to top outlet mm	1058	1058 / 1291	1285
Energy efficiency class	A+	A+	A+
Nominal kW	6	6	6
Weight kg	117	234 → 191	135
Fuel volume kg	1,24	1,24	1,24
Combustion chamber width mm	340	340	340
Distance to flammable materials			
At the sides mm	350	350	350
Behind stove mm	150	150	150
Distance to furniture mm	1000	1000	1000
Efficiency			
Ecodesign requirement of 75%	82	82	82
Dust measurement			
Ecodesign requirement of 40 Mg/Nm ³ 13% O ₂	16	16	16

options

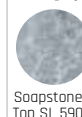
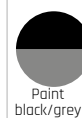

Details



8 Liter ash bucket



Cast iron door

More on heta.dk

Scan-Line 7B

Compact, modern design

Scan-Line 7 is available in many options from the traditional steel stove to a combination with either soapstone or blackwood. Scan-Line 7 can be wall-hung or mounted on a pedestal with a swivel function.

The Scan-Line 7 series is the perfect stove for smaller heating requirements.

*Scan-Line 7B
soapstone*



**Scan-Line 7B****Scan-Line 7B**
soapstone top**Scan-Line 7B**
soapstone**Scan-Line 7B**
blackwood**Scan-Line 7B**
log store**Scan-Line 7C**
soapstone top**Scan-Line 7D**
blackwood top
rotating pedestal**Scan-Line 7L**
log store

Technical info

7B + C + D + L



∨

Options

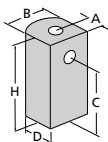
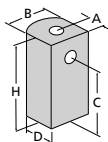
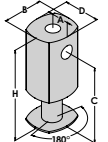
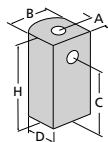
Oven model	7B	7C	7D	7L
mm	 <p>A: 196 B: 462 C: 698 D: 415 H: 880</p>	 <p>A: 220 B: 462 C: 525 D: 440 H: 710</p>	 <p>A: 196 B: 462 C: 883 / 896 D: 415 H: 1063 / 1076</p>	 <p>A: 195 / 196 B: 462 / 470 C: 541 D: 415 / 416 H: 725 / 754</p>
Floor to top outlet mm	812	640	994 / 1013	656
Energy efficiency class	A+	A+	A+	A+
Nominal kW	4,5	4,5	4,5	4,5
Weight kg	96 → 149	93 → 105	103 → 118	88 → 100
Fuel volume kg	1	1	1	1
Combustion chamber width mm	306	306	306	306
Distance to flammable materials				
At the sides mm	100	100	100	100
Behind stove mm	100	non flammable wall	100	100
Distance to furniture mm	800	800	800	800
Efficiency				
Ecodesign requirement of 75%	83	83	83	83
Dust measurement				
Ecodesign requirement of 40 Mg/Nm ³ 13% O ₂	15	15	15	15



Only complete blackwood on 7B

Details



8 Liter ash bucket



3 Liter ash bucket



Rotating pedestal



Optimal combustion

More on heta.dk

Stone options

Soapstone

Soapstone looks fascinating, but it also stores large inner values. Soapstone keeps the heat long after the fire has gone out. Soapstone releases the heat very slowly and consistent to the room. After only 2-3 fillings the slightly larger soapstone stoves keep the room heated for up to 14 hours, so you do not get up cold in the morning. Soapstone is a 3 billion years old mineral available in different hardness and colours. HETA's soapstone is grey, but due to the fantastic play of colours not two stones are identical.

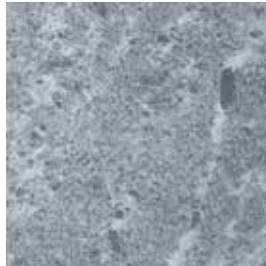

Soapstone is available for Scan-Line 900 / 900 side windows series, Scan-Line 800 series (not M models), Scan-Line 800 side windows models only the top (not M models), Scan-Line 500 series, Scan-Line 7 series, Scan-Line 8 series, Scan-Line 1000 series, Scan-Line 80 series, Scan-Line 40/50, Scan-Line 10, 20, 30, Scan-Line Green 250/150, Napoli and Turin.

Sandstone and Blackwood

Sandstone keeps the heat long after the fire has gone out. Sandstone also gives your stove character. Sandstone is available in many different colours. Some sandstone looks like wood with structure and grains. HETA's sandstone comes from the Himalaya mountains at around the 2900 meters elevation. Sandstone is a fine-grained natural stone tied together by quartz sand. The fantastic play of colours in the stone comes from compaction through billions of years and surface flow. Thus, not two stones are equal.

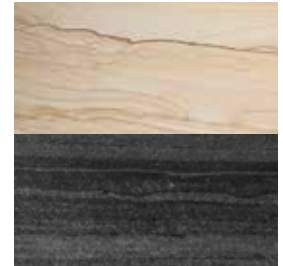

Tobacco sandstone is available for Scan-Line 800 series (not M models), Scan-Line 800 side windows models only the top (not M models), Scan-Line Green 250. Blackwood is available for Scan-Line 800 series (not M models), Scan-Line 800 side windows models only the top (not M models), Scan-Line 1000 series, Scan-Line Green 250, Scan-Line 900 / 900 side windows series, Scan-Line 510/520B complete blackwood only and Scan-Line 7B.

Ceramic

Ceramic tiles keep the heat long after the fire has gone out. The tiles also give your stove character. You can choose among 42 different colours. You can combine the colours to precisely suit your wish and your housing style.



Ceramic tiles are available for Scan-Line 800 series, Scan-Line 500 series, Scan-Line 80 XL series (white), Scan-Line Tour 10, 20, 30, Napoli and Turin.

Limestone

Limestone is a natural stone crafted over millions of years. Limestone has been used throughout the ages, from buildings to sculptures and now it is available on selected HETA stoves and pellet stoves. HETA's Limestone will give your stove a unique appearance, as well as hold the heat from the fire, releasing it slowly after the fire has gone out. Limestones Travertine like appearance, is stylish and timeless, fitting perfectly into your homes design.



Limestone is available for Scan-Line 800 (not M models), Scan-Line 800 side windows models only the top (not M models), Scan-Line Green 250, Scan-Line 900 series.

Ambition 5 + 8



Ambition 5

Enjoy the flames

Sit back relax and enjoy your wood burning experience with a HETA Ambition 5 or 8. Featuring a larger glass for viewing the mesmerizing flames, HETA's Clean Burn combustion controlled by a single lever, giving you superior control.

The Ambition 5 and 8 also has an easy to assemble log store, that can be purchased separately. Giving you the option to enjoy this impressive stove in any house.



Ambition 5



Ambition 5
log store



Ambition 5
log store with door



Ambition 8



Ambition 8
log store

Inspire 40 + 45 + 55

A versatile stove

Inspire has clean lines and exquisite materials and is ideal in any home and decor. Inspires are perfect for small, modern rooms and traditional country cottages or cabins. The Inspires combustion is very easy to control and combustion performance is excellent from as low as 3 kW.

The wide combustion chamber in Inspire 55 and Inspire 55 high gives a beautiful panoramic view of the flames plus lots of room for the wood. The large glass window provides extensive heat release to the room and makes Inspire 55 a very versatile stove. Inspire 55 is available with integrated log store.

Product data

- > 50 cm wood
- > Available as high and low series

Inspire 55





Inspire 40



Inspire 45



Inspire 55



Inspire 40
log store



Inspire 45
log store



Inspire 55
log store



Inspire 55HK

With cooking plate



The Inspire 55H with cooking plate, is a stove for heating and cooking. The highlight is the 42 x 16 cm polished and raised cooking plate, which is integrated in the top plate and offers space for several pots. On this you can boil water and prepare all delicious dishes, like on a kitchen stove.

The Inspire 55H with cooking plate is not only a wonderful heat source, but can also be used as a cooking area.

The large viewing window offers a cozy atmosphere, rounded off by a built in wood storage compartment.

Technical info

Ambition 5 + 8 + Inspire 40 + 45 + 55 + 55HK



Oven model	Ambition 5	Ambition 8	Inspire 40	Inspire 45	Inspire 55	Inspire 55HK
mm	<p>A: 137 B: 550 C: 516 / 817 D: 345 H: 619 / 920</p>	<p>A: 137 B: 550 C: 516 / 817 D: 416 H: 619 / 920</p>	<p>A: 113 B: 460 C: 467 / 737 D: 367 H: 584 / 855</p>	<p>A: 116 B: 540 C: 451 / 751 D: 377 H: 555 / 855</p>	<p>A: 130 B: 642 C: 451 / 807 D: 403 H: 555 / 910</p>	<p>A: 130 B: 642 C: 451 / 807 D: 403 H: 555 / 910</p>
Floor to top outlet mm	619	619	596 / 866	566 / 866	566 / 921	566 / 921
Energy efficiency class	A+	A	A+	A+	A	A
Nominal kW	5	6,5	4,5	4,9	6,3	6,3
Weight kg	98 → 113	110 → 131	74 → 92	80 → 106	108 → 131	108 → 131
Fuel volume kg	1,2	1,8	1,1	1,2	1,5	1,5
Combustion chamber width mm	470	482	370	424	560	560
Distance to flammable materials						
At the sides mm	400	400	340 / 400	300 / 300	420	420
Behind stove mm	200	225	120 / 190	195 / 150	220 / 150	220 / 150
Distance to furniture mm	1100	1100	900	860	1200	1200
Efficiency Ecodesign requirement of 75%	85	80	81	84	80	80
Dust measurement Ecodesign requirement of 40 Mg/Nm³ 13% O₂	16	23	27	13	28	28

options

Soapstone

Paint black/grey

Only soapstone top Inspire 45

Details



Quality cast iron



Air regulation



Top outlet



Cooking plate

More on [hetadk](http://hetadk.com)

Scan-Line 80XL + 80XL-B

Heat for many hours

Scan-Line 80XL-B and 80XL generate attention in every home. Scan-Line 80XL-B and Scan-Line 80XL consist of large solid soapstone or ceramic tiles. Scan-Line 80XL-B and 80XL is based on HETA's popular Scan-Line 800 combustion chamber which operates efficiently down to 3 kW.

Scan-Line 80XL-B and 80XL comes with two large heat storage stones. Together with the tiles it will store the heat for many hours after the last firing. Scan-Line 80XL-B has the same fine quality as 80XL.

Product data

- > Generates attention
- > Modern design
- > Generates heat for many hours
- > Large ash bucket
- > Extra storage room

*Scan-Line 80XL
ceramic*



Technical info 80XL + 80XL-B



Scan-Line 80XL
ceramic



Scan-Line 80XL-B
ceramic



Scan-Line 80XL
soapstone



Scan-Line 80XL-B
soapstone



Oven model	80XL	80XL-B
mm	<p>A: 302 B: 605 C: 1014 D: 585 H: 1793</p>	<p>A: 302 B: 605 C: 1014 D: 585 H: 1793</p>
Floor to top outlet mm	1521	1521
Energy efficiency class	A+	A+
Nominal kW	6,8	6,8
Weight kg	271 → 395	271 → 395
Fuel volume kg	1,5	1,5
Combustion chamber width mm	330	330
Distance to flammable materials		
At the sides mm	300	300
Behind stove mm	125	125
Distance to furniture mm	900	900
Efficiency		
Ecodesign requirement of 75%	81	81
Dust measurement		
Ecodesign requirement of 40 Mg/Nm ³ 13% O ₂	24	24

Options

- Soapstone
- White ceramic
- Paint black/grey

Details



8 Liter ash bucket



Pull out door

More on hetadk

Scan-Line 40 + 40B + 50 + 50B

Clean lines

Scan-Line 40 + 50 attracts attention with its beautiful strong design. You can use Scan-Line 40 + 50 as a traditional stove and it will heat a room up relatively quickly. Or you can close off the convection and use the thermal mass principle, allowing the 500 kg of soapstone to slowly release the heat over many hours.

Product data

- > Strong design
- > Generates heat for many hours
- > Perfect combustion



Scan-Line 40



Technical info

40 + 40B + 50 + 50B



Scan-Line 40



Scan-Line 40B



Scan-Line 50



Scan-Line 50B



>

options

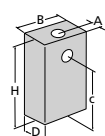
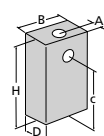
Oven model	40 + B	50 + B
mm	 <p>A: 205 B: 530 C: 916 D: 450 H: 1605</p>	 <p>A: 205 B: 530 C: 1431 / 1946 D: 450 H: 2120</p>
Floor to top outlet mm	1054	1054 / 1287
Energy efficiency class	A+	A+
Nominal kW	6	6
Weight kg	420 → 482	566 → 584
Fuel volume kg	1,24	1,24
Combustion chamber width mm	340	340
Distance to flammable materials		
At the sides mm	350	350
Behind stove mm	150	150
Distance to furniture mm	1000	1000
Efficiency		
Ecodesign requirement of 75%	82	82
Dust measurement		
Ecodesign requirement of 40 Mg/Nm ³ 13% O ₂	16	16

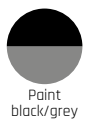

Details



8 Liter ash bucket



Pull out door

More on hetadk

Scan-Line 10 + 20 + 20B + 30 + 30B

Two in-one stove

Scan-Line 20B/30B is a modern thermal mass stove. You will heat a room up relatively quickly and then the 450-614 kg of soapstone and thermal stones will slowly release the heat over many hours. Allowing you to get a longer heating period out of your stove.

Product data

- > Round design
- > Generates heat for many hours
- > Can also be used as a traditional stove

Scan-Line 30B





Scan-Line 10



Scan-Line 20



Scan-Line 20B



Scan-Line 30



Scan-Line 30B

Scan-Line 30B
high

Scan-Line Tour 10 + 20 + 30

Top-class quality

Scan-Line Tour 10, 20 and 30 can all be equipped with extra heat accumulating stones inside the beautiful ceramic tiles. The combination of convection air, the accumulation of heat in ceramics and the heat accumulating stones, in all three models. This means that you both get the spreading of heat while the stove burns and then storage of heat released overnight.

Product data

- > Throughout quality
- > Sensational design
- > Generates heat for many hours

Scan-Line Tour 30





Scan-Line Tour 10



Scan-Line Tour 20







Scan-Line Tour 30

Technical info

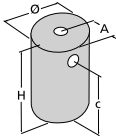
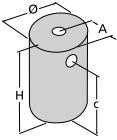
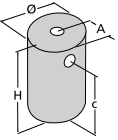
10 + 20 + 20B+ 30 + 30B + Tour 10 + Tour 20 + Tour 30

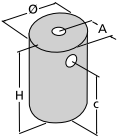
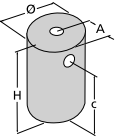
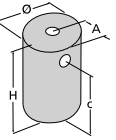

Oven model	10	20 + B	30 + B	Options	Tour 10	Tour 20	Tour 30	Options
mm	 <p>A: 264 B: 640 C: 1068 D: 640 H: 1261</p>	 <p>A: 264 B: 640 C: 1330 D: 640 H: 1523</p>	 <p>A: 264 B: 640 C: 1592 D: 640 H: 1785</p>	 Soapstone  Paint black/grey	 <p>A: 310 B: 620 C: - D: 620 H: 1380</p>	 <p>A: 310 B: 620 C: 1298 D: 620 H: 1684</p>	 <p>A: 310 B: 620 C: 1602 D: 620 H: 1988</p>	 Ceramic 42 colours  Paint black/grey
Floor to top outlet mm	952	952	952		978	978	978	
Energy efficiency class	A+	A+	A+		A+	A+	A+	
Nominal kW	66	6	6		6	6	6	
Weight kg	451	519	614		254	292	330	
Fuel volume kg	1,24	1,24	1,24		1,24	1,24	1,24	
Combustion chamber width mm	340	340	340		340	340	340	
Distance to flammable materials At the sides mm Behind stove mm	350 150	350 150	350 150		350 150	350 150	350 150	
Distance to furniture mm	1000	1000	1000		1000	1000	1000	
Efficiency Ecodesign requirement of 75%	82	82	82		82	82	82	
Dust measurement Ecodesign requirement of 40 Mg/Nm ³ 13% O ₂	16	16	16		16	16	16	

Details



Ash bucket



Beautiful ceramic tiles



Optimal combustion



Baking oven

More on heta.dk

Scan-Line Solid C



Technical info Scan-Line Solid C

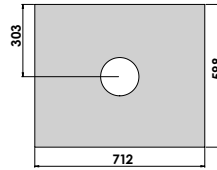

∨

options

Oven model	Scan-Line Solid	options
mm	<p>A: 303 B: 712 C: 1324 D: 598 H: 1632</p>	<p>Paint black/grey</p>
Floor to top outlet mm	1107	
Energy efficiency class	A	
Nominal kW	8,5	
Weight kg	325 → 400	
Fuel volume kg	2,1	
Combustion chamber width mm	614	
Distance to flammable materials At the sides mm Behind stove mm	550 -	
Distance to furniture mm	1100	
Efficiency Ecodesign requirement of 75%	79	
Dust measurement Ecodesign requirement of 40 Mg/Nm ³ 13% O ₂	27	

Details



Quality materials



Convection top

More on [hetradk](#)

Thermal mass stoves

Stay warm for many hours

Draw admiring glances while you stay warm! HETA's exclusive thermal mass stoves draw generate attention and fulfil all your wishes. You can use the thermal mass stove as a traditional stove with quick heating, or you can take advantage of the thermal mass stove and let it release the heat slowly over many hours.

By having a HETA thermal mass stove in your home you also save wood, as our thermal mass stove stores the heat for up to 18 hours. Our therma-stones are made of a special material based on concrete which absorb the heat particularly well and release the heat over a longer period.

There is more on heta.dk



Scan-Line 1000S

Scan-Line 800
therma-stones

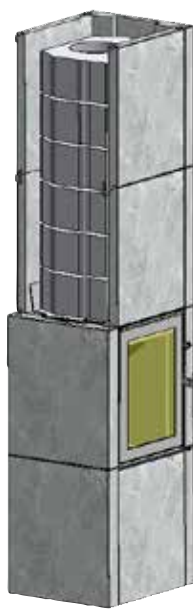

Scan-Line 50



Scan-Line 830S

Comparing therma capacity

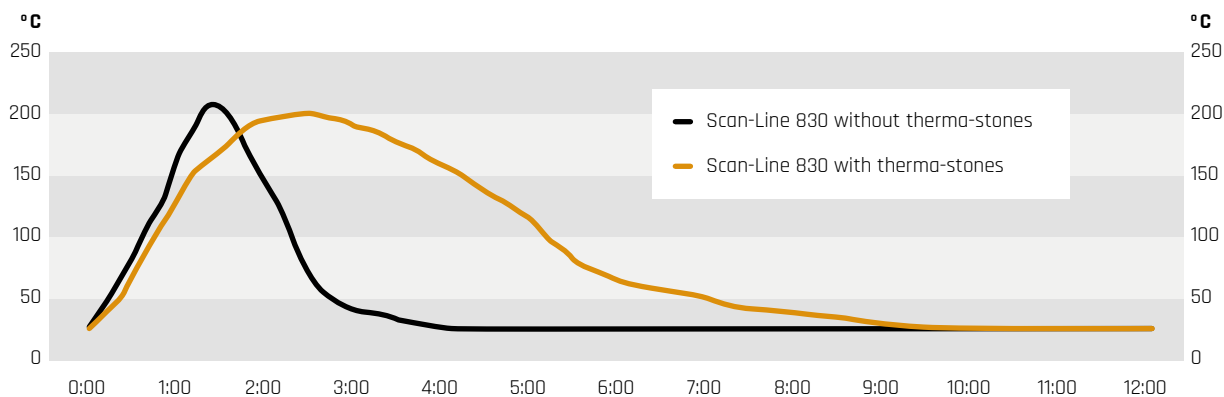

Optimal combustion

HETA Automatic Combustion

HETA makes it easy to fire correctly with HETA Automatic Combustion. The automatically-controlled air supply means that you just have to add wood to your stove to achieve optimum combustion. After filling up, HETA Automatic Combustion tells you when to fire again.

The module can be set to three different temperature levels. When HETA Automatic Combustion is set at a temperature level, the stove burns optimally – fully automatically.

You get a detailed overview of the combustion with HETA Automatic Combustion. The module is built into the stove and has a freestanding display giving you all the information you need.



HETA Automatic Combustion is available for Scan-Line 8, 500, 800, 900, 1000, 80, 40/50, 10-20-30.



Scan-Line 95 + 100

Scan-Line 95H

Spread the coziness

Scan-Line 95 + Scan-Line 100 are beautiful and give extensive heat release and coziness. The stove seems almost to float on air and if you choose the model with swivel pedestal you can spread the heat and mesmerising coziness exactly where you want it. The unique and new combustion technique provides an amazing combustion.

Product data

- > Panoramic view of the flames
- > Elegant closing mechanism
- > Fantastic combustion



Scan-Line 95



Scan-Line 95H
log store



Scan-Line 95
rotating pedestal



Scan-Line 100
rotating pedestal



Scan-Line 100
short bench



Scan-Line 100
long bench



Options

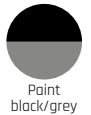

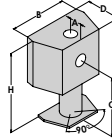
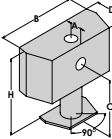
Oven model	95	100
mm	 A: 151 B: 760 C: 739 / 754 D: 433 H: 1007 / 1022	 A: 151 B: 1019 C: 742 / 758 D: 433 H: 1007 / 1022
Floor to top outlet mm	943 / 961	883 / 901
Energy efficiency class	A	A+
Nominal kW	7,2	9,9
Weight kg	142	172
Fuel volume kg	1,9	2,3
Combustion chamber width mm	548 / 462	808 / 730
Distance to flammable materials		
At the sides mm	350	250
Behind stove mm	150	100
Distance to furniture mm	1100	1200
Efficiency Ecodesign requirement of 75%	80	81
Dust measurement Ecodesign requirement of 40 Mg/Nm ³ 13% O ₂	28	15

Scan-Line Prestige A + B + C

Clean and strong design

Scan-Line Prestige matches modern interior design and having windows on up to three sides you can enjoy the view of the flames from all angles. Scan-Line Prestige is available in four different models. You get an elegant solution in your home no matter which model you choose. The design is clean and strong and matches modern interior design.

All visible sides are made from cast iron and at the same time, the frames around the convection box can be customized. The door is opened and closed soundless with the discrete handle, and you can decide on which side the handle is placed.

Scan-Line Prestige C



Product data

- > Can be customized
- > Optional windows on three sides



Scan-Line Prestige A



Scan-Line Prestige BR



Scan-Line Prestige BL



Scan-Line Prestige C



Scan-Line Panorama + Panorama XL

Almost like a painting

Scan-Line Panorama gives you an exceptional panoramic view of the flames. The fire insert is easy to operate, and the large, stylish panoramic window with an almost hidden control handle is beautiful and looks almost like a piece of art hanging on the wall.

Scan-Line Panorama is available with customized front frames that fits into your home precisely.

Product data

- > Modern design
- > Hidden control handles
- > Can be customized



Scan-Line Panorama



Scan-Line Panorama XL



Scan-Line Vista

Modern and compact

HETA's Vista insert is a modern compact insert, with a panoramic view of enchanting flames through the wide glass door. With HETA's signature single air control, Vista's combustion is easy to control, giving you the heat or cozy atmosphere, you desire.

Along with ease of control the Vista has a stylish integrated door handle and self-latching door, making lighting and re-fueling your Vista enjoyable.

Vista is the perfect insert for new homes and designed to be placed in most existing open fireplaces,

its measurements are as follows Width 694 mm, Height 489 mm and Depth 453 mm.

You have the option of a stylish frame, custom frame or installing it frameless, thanks to the Vista's 3 mm ridged convection case.

If your installation requires direct air, an optional fresh air connector can be purchased separately.



Scan-Line Vista



Scan-Line Vista S

Scan-Line Classic 1 + 2



Scan-Line Classic 2

Beautiful view of the flames

Scan-Line Classic with its clean lines merges into the modern and stylish home. You have a beautiful view of the flames through the panoramic window.

Product data

- > Modern design
- > Hidden control handles
- > Panoramic window



Scan-Line Classic 1



Scan-Line Classic 2



Inspire 40 insert

Inspire 40 insert

Small and robust

Enjoy the flames in our trendy fire inserts Inspire or Scan-Line 550. HETA's clean burn combustion technique, controlled by one single handle, gives you a perfect view through the clear portrait window. Inspire and Scan-Line 550 are the perfect choices for smaller rooms or a cozy moment.

Product data

- > Small and high
- > Good for smaller rooms



Inspire 40
floor



Inspire 40
floor



Inspire 40
wall



Inspire 40
wall

Builders hole measurements

Vista

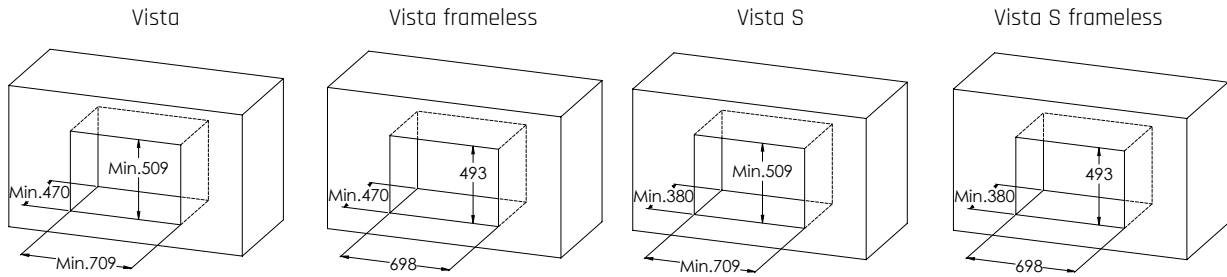

Prestige

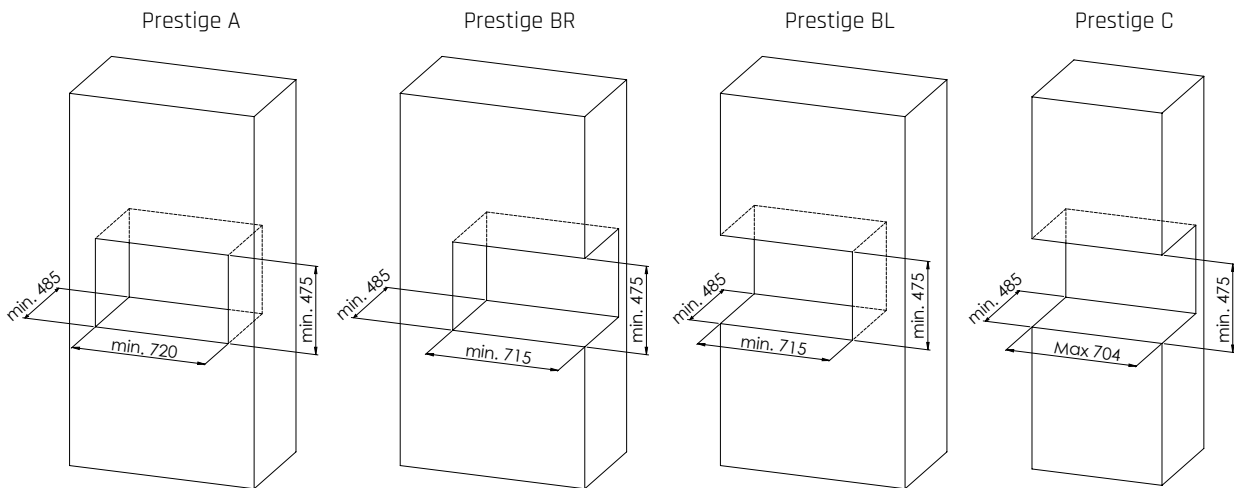

Panorama

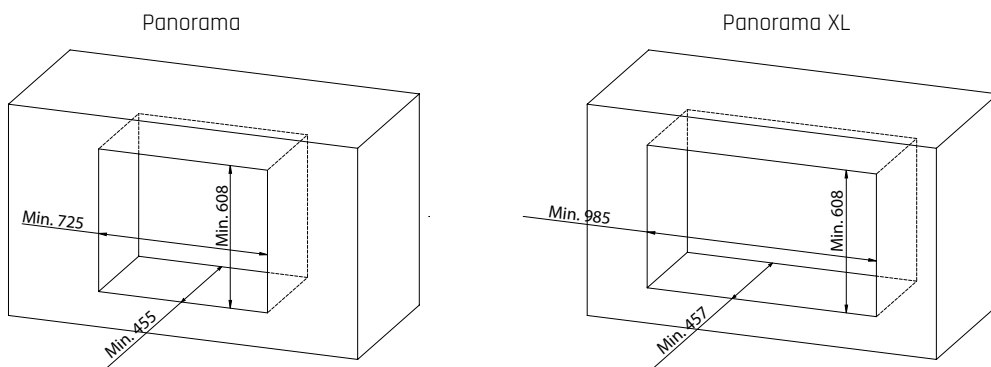

Classic

Classic 1

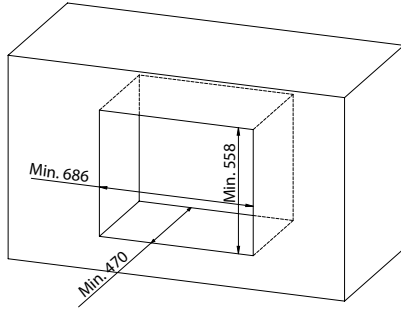

Classic 2

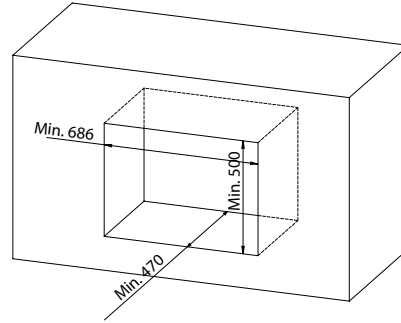

Inspire

Inspire floor model and wall model

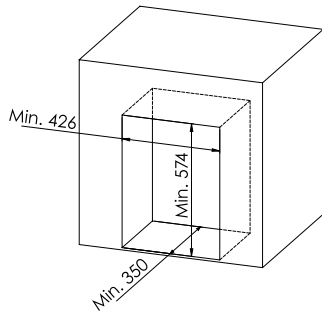

Inspire hidden wall model

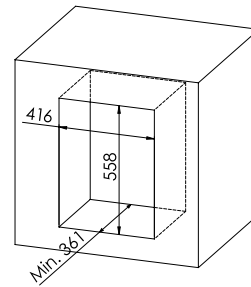

Technical info

Prestige A + B + C + Panorama + XL + Vista + S



Oven model	Prestige A	Prestige B	Prestige C	Panorama + XL	Vista	Vista S	Options
mm	 A: 294 B: 752 D: 463 H: 501	 A: 295 B: 731 D: 480 H: 501	 A: 294 B: 710 D: 480 H: 501	 A: 324 / 275 B: 778 / 1038 C: 322 / 313 D: 445 / 437 H: 647	 A: 289 / 304 (30°) B: 748 C: 439 (30°) D: 450 H: 543	 A: 198 / 213 (30°) B: 748 C: 444 (30°) D: 357 H: 450	 Paint black/grey
Floor to top outlet mm	-	-	-	-	-	-	
Energy efficiency class	A	A	A	A	A+	A	
Nominal kW	8,5	8,5	8,5	7,2 / 9,9	7,4	5	
Weight kg	92	96	101	112 / 145	106	87	
Fuel volume kg	2,1	2,1	2,1	1,9 / 2,3	1,76	1,25	
Combustion chamber width mm	614	614	614	548 / 462 808 / 730	544	440	
Distance to flammable materials At the sides mm Behind stove mm	- -	- -	- -	- -	110 150	300 75/150	
Distance to furniture mm	1100	1100	1100	1100 / 1200	1100	1100	
Efficiency Ecodesign requirement of 75%	79	79	79	81	81	79	
Dust measurement Ecodesign requirement of 40 Mg/Nm³ 13% O₂	23	23	23	15	12	13	

Details



Craftsmanship



Air regulation



Integrated control handles



Optimal combustion

More on heta.dk

Technical info

Classic 1 + 2 + Inspire 40 wall + floor



Oven model	Classic 1	Classic 2	Inspire 40 wall	Inspire 40 floor	options
mm	<p>A: 315 / 332 (30°) B: 735 D: 460 H: 601</p>	<p>A: 315 / 332 (30°) B: 735 D: 460 H: 543</p>	<p>A: 229 / 289 (45°) B: 501 D: 345 H: 598</p>	<p>A: 229 / 289 (45°) B: 481 D: 345 H: 578</p>	<p>Paint black/grey</p>
Floor to top outlet mm	-	-	-	-	
Energy efficiency class	A+	A+	A+	A+	
Nominal kW	7,4	7,4	5	5	
Weight kg	94	88	67 → 80	67 → 80	
Fuel volume kg	1,7	1,7	1	1	
Combustion chamber width mm	510	510	330	330	
Distance to flammable materials					
At the sides mm	-	-	-	-	
Behind stove mm	-	-	210	210	
Distance to furniture mm	1200	1200	900	900	
Efficiency					
Ecodesign requirement of 75%	81	81	84	84	
Dust measurement					
Ecodesign requirement of 40 Mg/Nm³ 13% O₂	31	31	9	9	

Details



Control handles



Handle



Different frames



Optimal combustion

More on hetadk

Scan-Line Green 150



Pellet stove - Scan-Line Green 150

Cozy and comfort

The Scan-Line Green 150 pellet stove from HETA, has made it easier for you to heat your house without compromise on comfort. The sleek designed, fully automatic pellet stove has large glass to view the flames spreading coziness throughout your house. The Scan-Line Green 150 is incredibly easy to operate and has a large intuitive color display. Set the desired temperature, power level and you can also save on fuel usage by programming your pellet stove to your heating needs.

In addition to ease of use and convenience the 150 will provide you with a cozy and comfortable warm. It will regulate the combustion air automatically, so it always has optimal combustion. Sit back and relax, once the desired temperature in the room is achieved the 150 will automatically adjust the output, until there is a need for heat again. We believe your pellet stove should be a statement in your home and fit into your home's interior. You can choose from sleek black or grey paint. Go bold and finish your Scan-Line Green 150 off with complete soapstone, giving you warm after the pellet stove is off, or finish it off with just a stylish soapstone top.



With HETA Climate WiFi module it is now possible to control your pellet stove with our HETA Climate app from your Smartphone. You can, for example, fire up in your country cottage before you arrive so it is warm and cozy already before you enter the house. HETA Climate can be downloaded to iOS and Android.

Technical info

Scan-Line Green 150

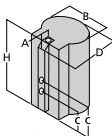

options

Oven model	Green 150	options
mm	 <p>A: 45 B: 470 C: 438 / 930 D: 614 H: 1035</p>	 Soapstone  Paint black/grey
Energy efficiency class	A+	
Nominal kW	7,3	
Weight kg	156 → 207	
Distance to flammable materials		
At the sides mm	90	
Behind stove mm	60	
Installed in a 45° corner	75	
Distance to furniture mm	770	
Efficiency	94	
Dust measurement Ecodesign requirement of 20 Mg/Nm ³ 13% O ₂	18	



Scan-Line Green 150



Scan-Line Green 150
soapstone top



Scan-Line Green 150
soapstone



Scan-Line Green 250

Pellet stove - Scan-Line Green 250

Heats easily 180 m²

HETA Scan-Line Green 250 matches the beautiful design of the woodburning stove with a beautiful view to the flames. Scan-Line Green 250 is available in so many design variants that it fits any type of interior design. You can choose Scan-Line Green 200 in steel, soapstone and sandstone.

The pellet stove has a unique combustion chamber, and the technology ensures an efficiency of an impressive 95 percent. Scan-Line Green 250 easily heats 180 m² of living space and - in some cases more, if the house is insulated according to the newest energy regulations.

The pellet tank stores up to 21 kg of pellets. The pellet stove is easily turned on, off and regulated with the remote or by using the touch display mounted on the pellet stove. With HETA Climate WiFi module it is now possible to control your pellet stove with our HETA Climate app from your Smartphone. You can, for example, fire up in your country cottage before you arrive so it is warm and cozy already before you enter the house. HETA Climate can be downloaded to iOS and Android.



Scan-Line Green 250



Scan-Line Green 250
soapstone top



Scan-Line Green 250
blackwood



Scan-Line Green 250
soapstone



Scan-Line Green 250
sandstone top



Scan-Line Green 250
limestone

Technical info Scan-Line Green 250



∨

options

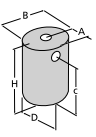
Oven model	Green 250
mm	 <p>A: 52 B: 547 / 560 C: 440 / 979 D: 600 / 603 H: 1076</p>
Energy efficiency class	A+
Nominal kW	8,8
Weight kg	167 → 249
Distance to flammable materials	
At the sides mm	150
Behind stove mm	80
Installed in a 45° corner	
Distance to furniture mm	650
Efficiency	95
Dust measurement Ecodesign requirement of 20 Mg/Nm³ 13% O₂	18

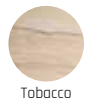

Scan-Line Green 250





Solid full welded and Danish produced steel construction



Convection element in cast iron

The technique

High efficiency and long operating life

Our thought out construction and solid fabrication of the combustion chamber and components ensures Scan-Line Green 250 high combustion, good functionality and long operating life.

Scan-Line Green 250 can be mounted directly on the chimney with smoke outlet to the back 30 cm and 44 cm high up, or with top outlet. Our innovative flue pipe system is of course in accordance with applicable international guidelines for fire protection and, in addition, the system makes the installation of the pellet stove much easier than normal.

21 kg

Extra large pellet tank for 21 kg pellets means longer time between filling ups.

95 %

The newly developed combustion chamber remove ensures an efficiency of up to 95 %.

8,8 kW

Highest output is 8,8 kW – enough to heat up a modern house of 180 m².

Scan-Line 805 Aqua



*Scan-Line 805 Aqua
soapstone top*

Aqua oven

Scan-Line 805 Aqua has specially sealed stove glass, significantly reducing radiated heat in the room. The beautiful flame presentation and high 87% efficiency reflects the innovative development work.

Give free rein to your imagination and exploit what they have to offer. The Scan-Line 800 aqua series comes with a safety valve for connection to existing systems. When connecting the stove, please ensure it has the ideal circulation pump flow rate of 140 litres/hour and that the existing

system is equipped with a safety valve which activates if the water pressure exceeds 2.5 bar.

The optional aqua kit prevents corrosion in the heat exchanger, as the return flow temperature is increased via the thermal three-way valve (bypass). The continual adjustment of a constant return water temperature ensures smooth combustion and optimal energy utilisation.

The aqua kit is an optional extra and is not included in the stove price.



Scan-Line Aqua 805



Scan-Line Aqua 805 soapstone

Technical info Scan-Line Aqua 805



∨

Options

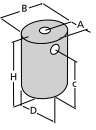
Oven model	Aqua 805
mm	 <p>A: 275 B: 576 C: - D: 506 H: 1216/1213</p>
Energy efficiency class	A+
Nominal kW	8,7
Weight kg	212 → 289
Distance to flammable materials	
At the sides mm	175
Behind stove mm	22
Distance to furniture mm	750
Efficiency	
Ecodesign requirement of 75%	87
Dust measurement	
Ecodesign requirement of 40 Mg/Nm ³ 13% O ₂	22

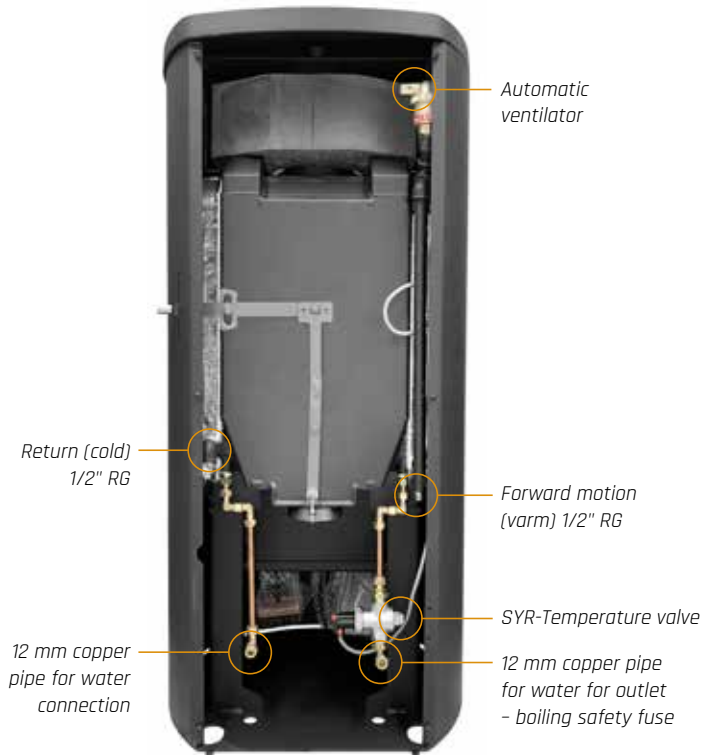



Scan-Line 8 Gas

HETA Scan-Line 8 Gas stove has a fantastic design and perfect size for most interiors and all room sizes. The stove is stylish, does not take up much space, and the large glass gives a formidable look to the flames. Scan-Line 8 Gas is also available with a top plate in soapstone. Scan-Line 8 Gas is produced at HETA.

HETA's Danish produced and designed gas stove, Scan-Line 8 Gas, has been created in collaboration with a large recognized European manufacturer of gas fireplaces who has many years of experience with gas products.

Wood, pellet and gas stoves from HETA are the perfect choice when the environment, quality, design and efficiency are paramount.

With Scan-Line 8 Gas, HETA is back in the gas market

after several years, and we are convinced that the time is now right again for clean-burning, environmentally friendly and comfortable gas stoves.

Available both in NG or LPG, for convenience of installation will we prepare the burner after order. So when you order a Scan-Line 8 Gas, it should be as easy as connecting the gas, flue and placing the beautiful ceramic logs.

Sit back, relax and enjoy your burning experience with a Scan-Line 8 Gas. Easily controlled with the supplied remote, for your convenience.



Scan-Line 8 Gas



Technical info Scan-Line 8 Gas



∨

Options

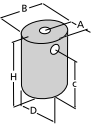
Oven model	8 Gas
mm	 <p>A: 222 B: 445 C: 875 D: 445 H: 1011 / 1029</p>
Energy efficiency class	A
Nominal kW	G20 7,3 G30 6,8
Weight kg	76
Distance to flammable materials	
At the sides mm	350
Behind stove mm	120
Distance to furniture mm	850
Efficiency	90
Dust measurement Ecodesign requirement of 40 Mg/Nm ³ 13% O ₂	



Only soapstone top

Facts

- > Balanced flue
- > NG or LPG
- > Burner is mounted
- > Optional soapstone top and/or flame enhancing glass in the fire chamber



Accessories

There's more to read on heta.dk



Power bank



Gel



Rubber mat

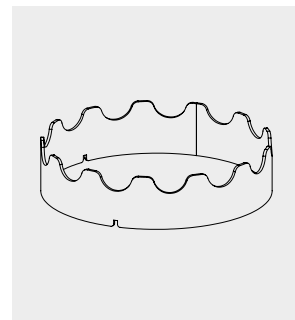

Cooking ring



Outdoor

Quad

HETA's Quad outdoor pellet burner is a new and revolutionary garden product that, in addition to, being a beautiful piece of furniture, can also extend summer evenings with a beautiful and warming fire.

Quad is made of the popular Corten steel, which Heta has used for outdoor products for many years. Corten steel forms a nice patina surface that can withstand all weather conditions. HETA Quad is 50 cm high and 37 cm wide at the bottom. The inner removable combustion chamber is filled with approx. 4 kg wood pellets, which gives nice high flames for approx. 1,5 hours, after which embers maintain a high temperature for another 1,5 hours. At the bottom of the HETA Quad, a fan is mounted which, together with the included power bank, ensures the controlled combustion.

HETA Quad is ideal for the terrace, where it will create atmosphere, light and coziness in the late hours. Just as it is great for welcoming guests at the entrance of the house or in front of the restaurant. When the flames die out, the subsequent glow layer is ideal for children to make marshmallows etc.

The combustion is completely odor and smoke free, and the only thing you hear are the flames dancing. When the fire and embers die out, the combustion chamber is removable making it easy to empty the little ash that has not been burned, once empty the combustion chamber can be refilled with dry wood pellets. Then reapply the supplied gel, which easily ignites the pellets, and the cozy fire continues.







Outdoor

Coziness in the garden with Tipi

Do you also miss the stove in the summer? With HETA's Tipi you can move the coziness of the stove out and into your garden. HETA Tipi gives heat and coziness on the terrace or in the grass. You can make popcorn and bread on a stick, roast marshmallows, sausages and anything you would like to cook over the open fire. HETA Tipi is easy to light up and easy to clean.

HETA Tipi is a beautiful sculpture in your garden. Tipi is designed for any climate and it can stay outside all year long. HETA Tipi is made from Corten steel which develops a nice, rusty-red colour over time, but this never develops into corroding rust.

Accessories

- > Grill to Tipi 147
- > Galvanized steel plate



Extend the summer evenings

Live fire calms the soul and provides a coziness after a hard day's work. HETA Tipi is a new and different terrace warmer that brings out the best in terms of functionality, design, environment, durability and live fire. HETA Tipi gives a comfortable warmth during cool summer evenings. It is practical, easy to use and clean.

In HETA Tipi you can make bread on a stick, make popcorn, grill sausages, bake pizza and many other nice treats.

HETA Tipi has a sculptural effect regardless of the time of year. Tipi is designed for the Danish climate and you can enjoy the coziness and heat all year long. When HETA Tipi has been outside from April to September there will be a beautiful, smooth layer of patina on the surface.

Tipi is available in 3 sizes: 147 cm, 120 cm and 96 cm.



Manage your firewood

Get rid of piles of wood on the terrace or on the grass. Manage your firewood with a HETA Hexagon and Trapez wood shelf and get a nice sculpture in your garden at the same time. Hexagon can also be used as a table or bench. Hexagon and Trapez are made from Corten steel, just like HETA Tipi, which develops a fantastic, rusty-red colour over time.





Can you think of anything better than roasted marshmallows in the garden together with your loved ones? HETA Tipi provides coziness all year round.

Manage your firewood with HETA's wood shelves in beautiful Corten steel.



Accessories

Most stoves need accessories. A good firewood basket is a must. Available in different sizes. It is also important that you maintain your stove to ensure the best output and clean burn. As an example, you can replace the gaskets in the stove, repair outside damages, and keep the oven clean.

If you have a baking oven, a thermometer can keep track of the heat. You must use a grill and a dish when you bake bread and cook in the oven.

Swivel plates

HETA's turntable plates gives you the ability to view your stove 120, 180 or 360 degrees.



Glass plate for Tipi wood shelves

Fits Hexagon and Trapez.



Tipi grill

Use the grill for cooking in Tipi 147 cm – e.g. for grilling sausages.

Firewood baskets

Available in different sizes. Made of recycled rubber. All baskets are unique.



Firewood basket Ø50 x H30



Firewood basket Ø40 x H30



Firewood basket Ø35 x H20



Firewood basket Ø30 x H30



Fireside tool set

HETA's elegant fireplace tool set, available in white or black.



Fireside tool set

For Scan-Line 7 series, 500, 520, Napoli and Turin.

Fireside glove

You can use the glove when you add wood to the fire, or when you adjust the damper on the stove.





Fresh air kit

External wall pipe and vent, 1,5 m flex pipe. Insulation, heat tape, 2 clamps.



HETA Wifi Module

HETA Climate Wifi module makes it possible to control your pellet stove with our HETA Climate app from your Smartphone. You can, for example, fire up in your country cottage before you arrive so it is warm and cozy already before you enter the house. HETA Climate can be downloaded to iOS and Android.

Glass cleaner

HETA's glass cleaner is specially formulated to not harm your glass, while making it easy to clean.



Graphite spray for lubrication



Senotherm spray paint

Refresh the stove. It is easy to repair small damages in the colour using Senotherm spray paint to make your stove look fresh and nice again. Senotherm spray paint tolerates heat and is easy to use.



Door, gasket set

If the door in the stove does not seal properly it must be replaced. This is easy to do using this set which includes both gasket and glue.

Accessories for **baking stoves**



Thermometer

Helps you to keep track of the heat in the baking oven.



Grill for baking stove

A perfect fit for your baking oven.



Dish for baking stove

Prepare a delicious dish in your baking oven.

Accessories

Glass plates

HETA's glass plates protect your floor from ash and burns and at the same time your stove gets a nice finish. Glass plates from HETA are made from 6 mm tempered glass and can resist the heat and weight from both stove and chimney.

Our universal glass plates fit all stoves, but we also have special glass plates for the Scan-Line 7B, Scan-Line 8, Scan-Line 500, Scan-Line 800, Scan-Line 900 series and Scan-Line 1000, and the glass plates are easy to remove when you are cleaning.



Scan-Line 900 0021-014465

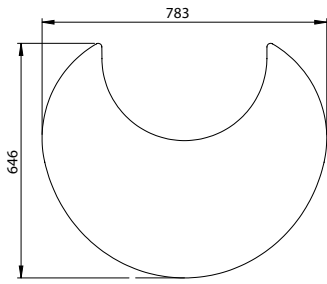

Scan-Line 900 DE 0021-014873

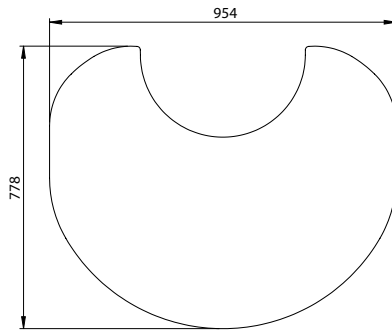

Scan-Line 7B
0021-014466 [DE 0021-026111]

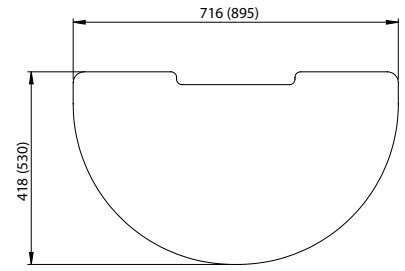

Scan-Line 8 universal 3535-0104

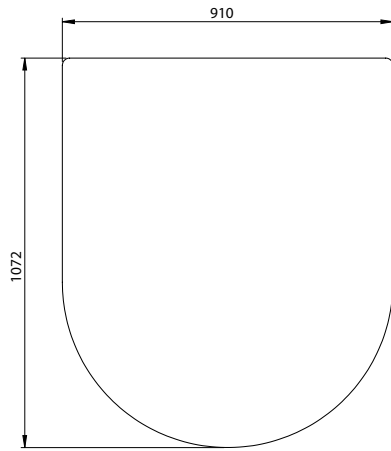

Scan-Line 8 DE 3535-0103

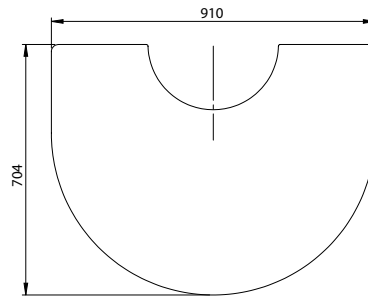

Scan-Line 8 1013-011481

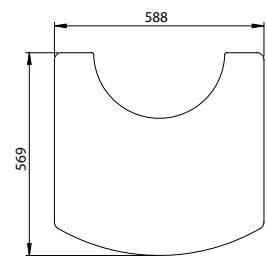

Universal 3535-0102

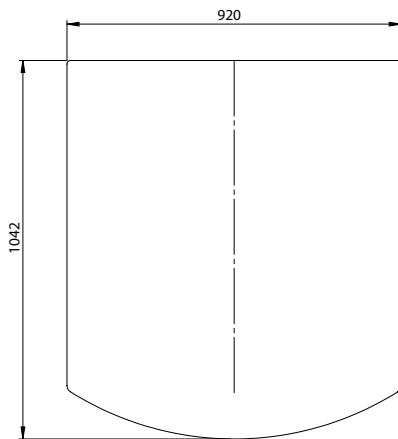

Scan-Line 1000 3535-0105

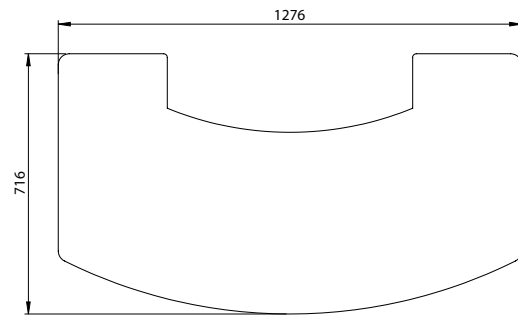

Scan-Line 800 3535-0100

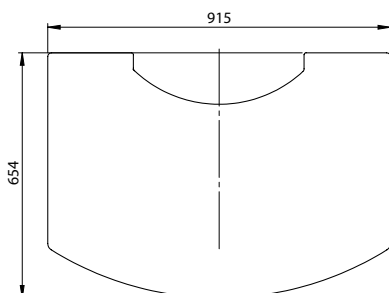

Scan-Line 500 3535-0101

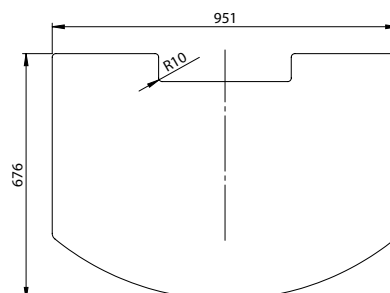



Scan-Line 820S

09.2023 Print: strandbyggednk Photo: HETA



Jupitervej 22 | DK-7620 Lemvig | heta.dk

Dealer